

BC H9G

A 5 H9F 5 @ "\$%&" HB 'D@5 H98 'G+99@6F ÷ <H: B G<

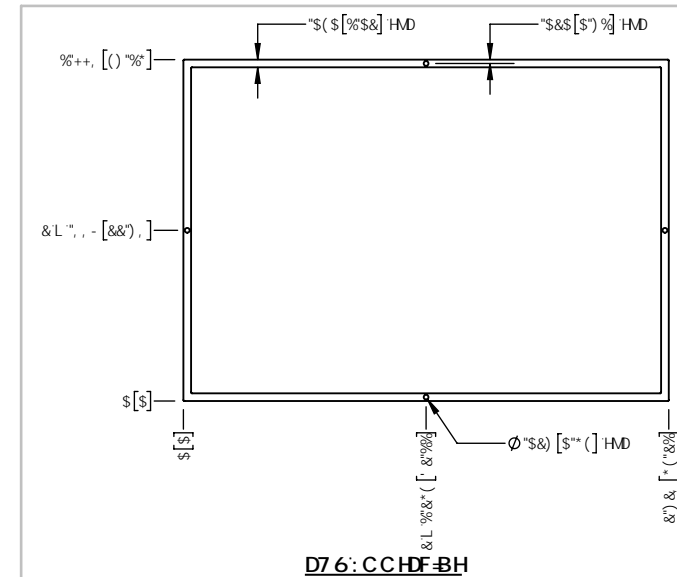
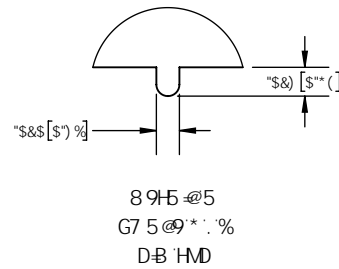
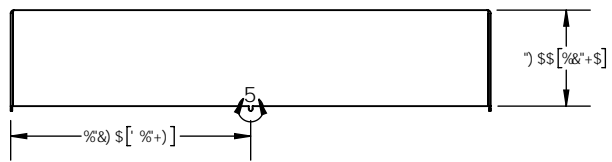
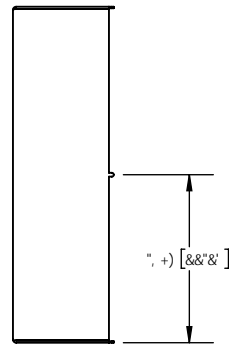
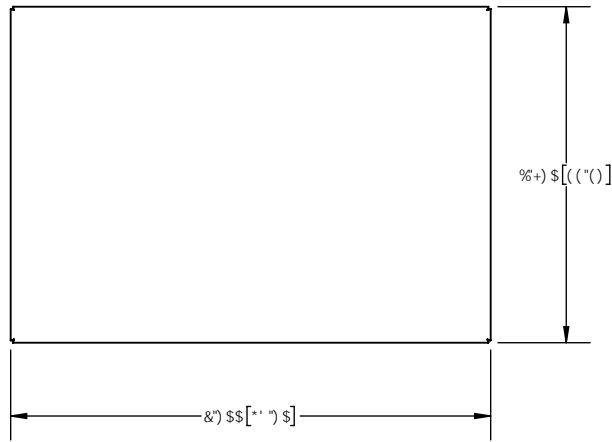
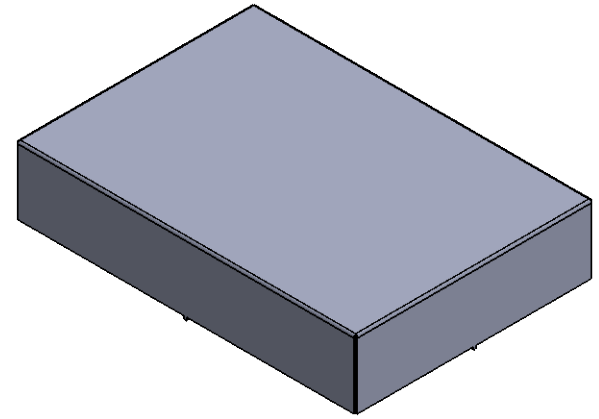

D76: CCHDF-BH

PROPRIETARY NOTICE: THESE DRAWINGS, LISTS OR SPECIFICATIONS ARE THE CONFIDENTIAL INFORMATION AND/OR TRADE SECRETS OF 3G SHIELDING SPECIALTIES IP, AND ISSUED IN STRICT CONFIDENCE. EXCEPT AS AUTHORIZED BY 3G SHIELDING SPECIALTIES IN WRITING, THESE DRAWINGS, LISTS OR SPECIFICATIONS SHALL NOT BE REPRODUCED, TRANSMITTED, USED FOR THE DESIGN, MANUFACTURE OR SALE OF EQUIPMENT OR USED FOR ANY OTHER PURPOSE OTHER THAN EVALUATION.

IB@XGC H:9FK 49 CD97 ÷ 98
I #A LC @X SB 7 9
B7 <9G \$S\$S\$



D5FHBI A 69F
E 69 G' \$+
8 9G7 F-DHC B
E I 69
G7 5 @ % %
G<99H %C : %

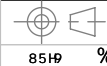

FC < G
7CA D86 B 7 9
853984* #91

85HP %!\$%&* & %