

BC H9G

A 5 H9F 5 @ "\$%&" HB 'D@5 H98 'G+99@6F ÷ <H: B G<

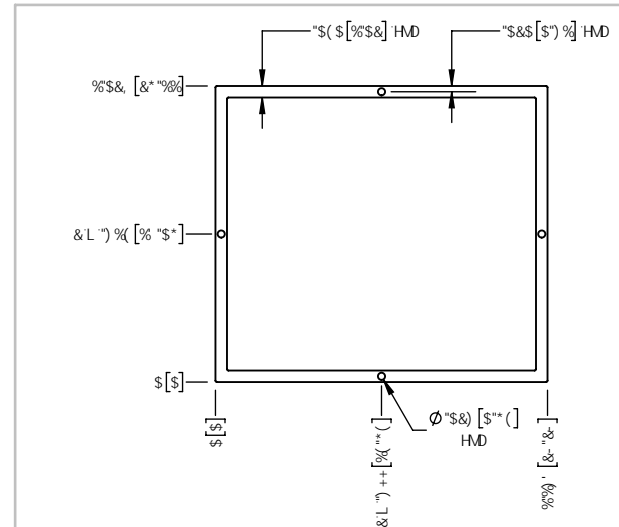
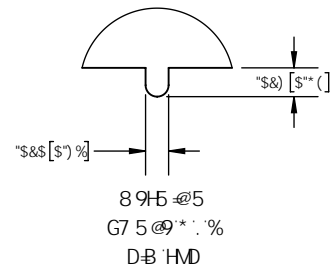
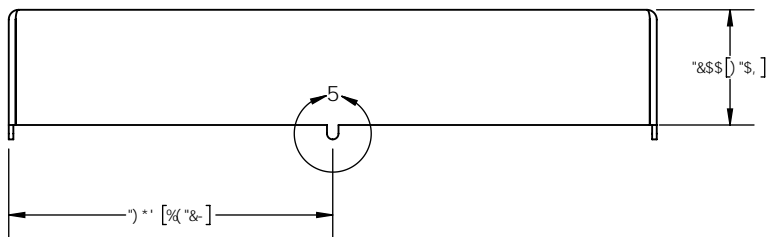
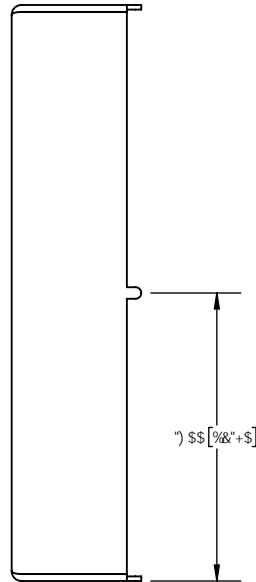
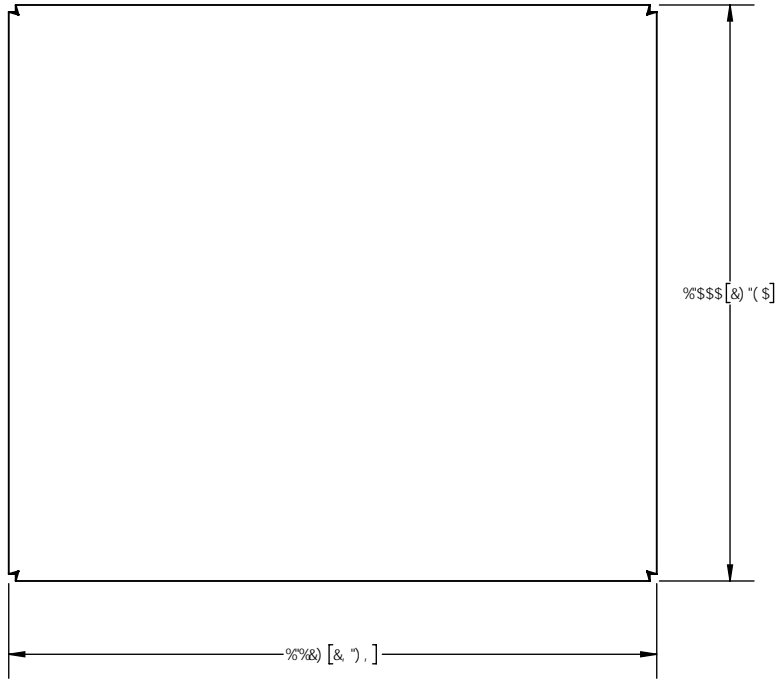
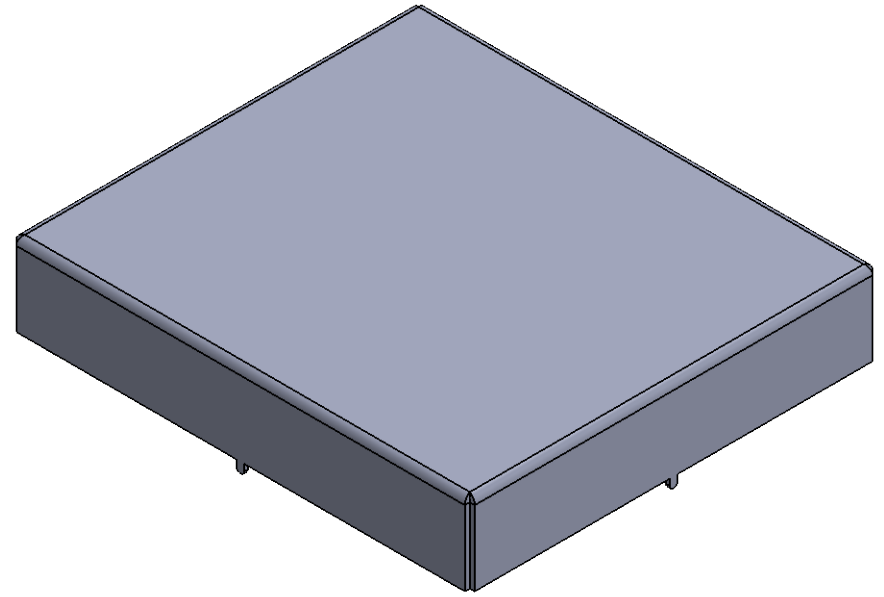

D76: CCHDF-BH

PROPRIETARY NOTICE: THESE DRAWINGS, LISTS OR SPECIFICATIONS ARE THE CONFIDENTIAL INFORMATION AND/OR TRADE SECRETS OF 3G SHIELDING SPECIALTIES LP., AND ISSUED IN STRICT CONFIDENCE. EXCEPT AS AUTHORIZED BY 3G SHIELDING SPECIALTIES IN WRITING, THESE DRAWINGS, LISTS OR SPECIFICATIONS SHALL NOT BE REPRODUCED, TRANSMITTED, USED FOR THE DESIGN, MANUFACTURE OR SALE OF EQUIPMENT OR USED FOR ANY OTHER PURPOSE OTHER THAN EVALUATION.

IB@9GGCH:9FK 499 CD97 = 90
I #A LC @9F 5B 7 9
"B7 <9G \$S\$S\$



D5FHBI A 69F F9J"
E 69G' \$(\$
8 9G7 F-DHC B E I 69
G7.5 @9 ' .% G<99H %C : %

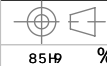

FC < G
7CA D06E B7 9
859047) #91

85HP %!\$%&*

& %