

NOTES:

- MATERIAL: 0.012" TIN PLATED STEEL BRIGHT FINISH

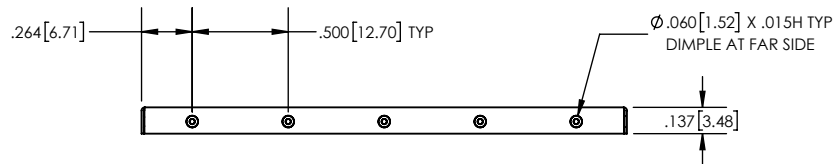
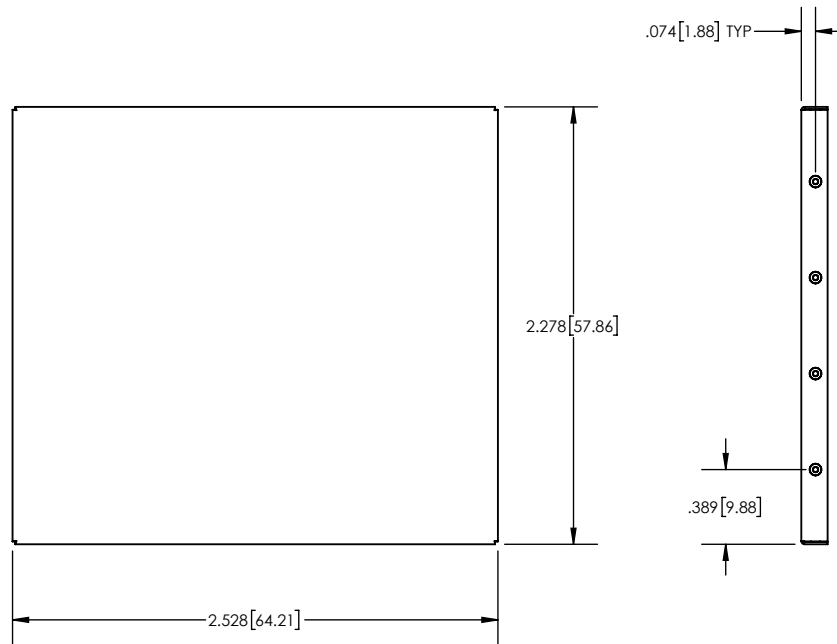
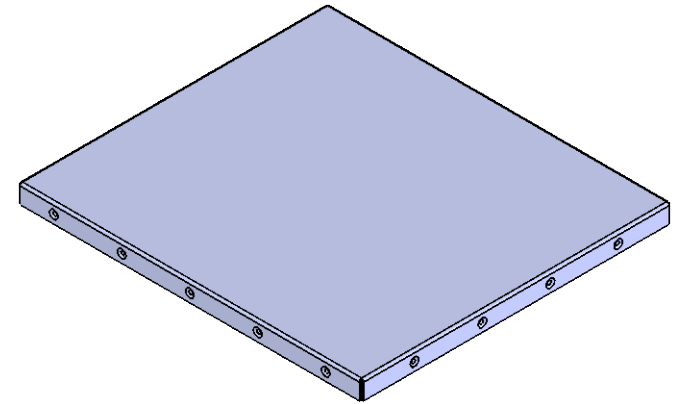

**PROPRIETARY NOTICE:** THESE DRAWINGS, LISTS OR SPECIFICATIONS ARE THE CONFIDENTIAL INFORMATION AND/OR TRADE SECRETS OF 3G SHIELDING SPECIALTIES LP., AND ISSUED IN STRICT CONFIDENCE. EXCEPT AS AUTHORIZED BY 3G SHIELDING SPECIALTIES IN WRITING, THESE DRAWINGS, LISTS OR SPECIFICATIONS SHALL NOT BE REPRODUCED, TRANSMITTED, USED FOR THE DESIGN, MANUFACTURE OR SALE OF EQUIPMENT OR USED FOR ANY OTHER PURPOSE OTHER THAN EVALUATION.

UNLESS OTHERWISE SPECIFIED U/M INCHES	TOLERANCE ±0.005
DATE	16-01-26



PART NUMBER <b>FLX-S-407C</b>	REV. <b>0</b>
DESCRIPTION FLEX	SHEET 1 OF 1
SCALE 1:1	